

TD1880 Precision Multi-function Calibrator



1. Summary

TD1880 is a multi-function calibrator with wide range and high accuracy, integrates AC/DC voltage and current standard source, can output excellent DC\AC voltage, DC\AC current, DC\AC power, phase, frequency, and analog resistance and capacitance etc. It's applied for calibrating 6.5 digits or below and other precision electrical measuring instruments.

2. Features

- DC voltage output: \pm (0~1020 V)
- DC current output: \pm (0 ~ 20.5 A)
- AC voltage output: 1mV ~ 1020 V
- AC current output: 29 μ A ~ 20.5 A
- Sinusoidal wave frequency: 10 Hz ~ 500 kHz
- Simulated DC resistance: 0 Ω ~ 1100 M Ω , Continuously adjustable.
- 2 MHz square wave frequency output
- U-I phase adjustment output
- AC/DC power output
- Multiple value output methods
- Capacitance output (function option): 1.1nF ~ 30 mF, continuously adjustable
- 8 kinds of thermocouple output and measurement (option)
- 6 kinds of thermal resistance output (option)
- Support clamp meter calibration (option)

3. Application

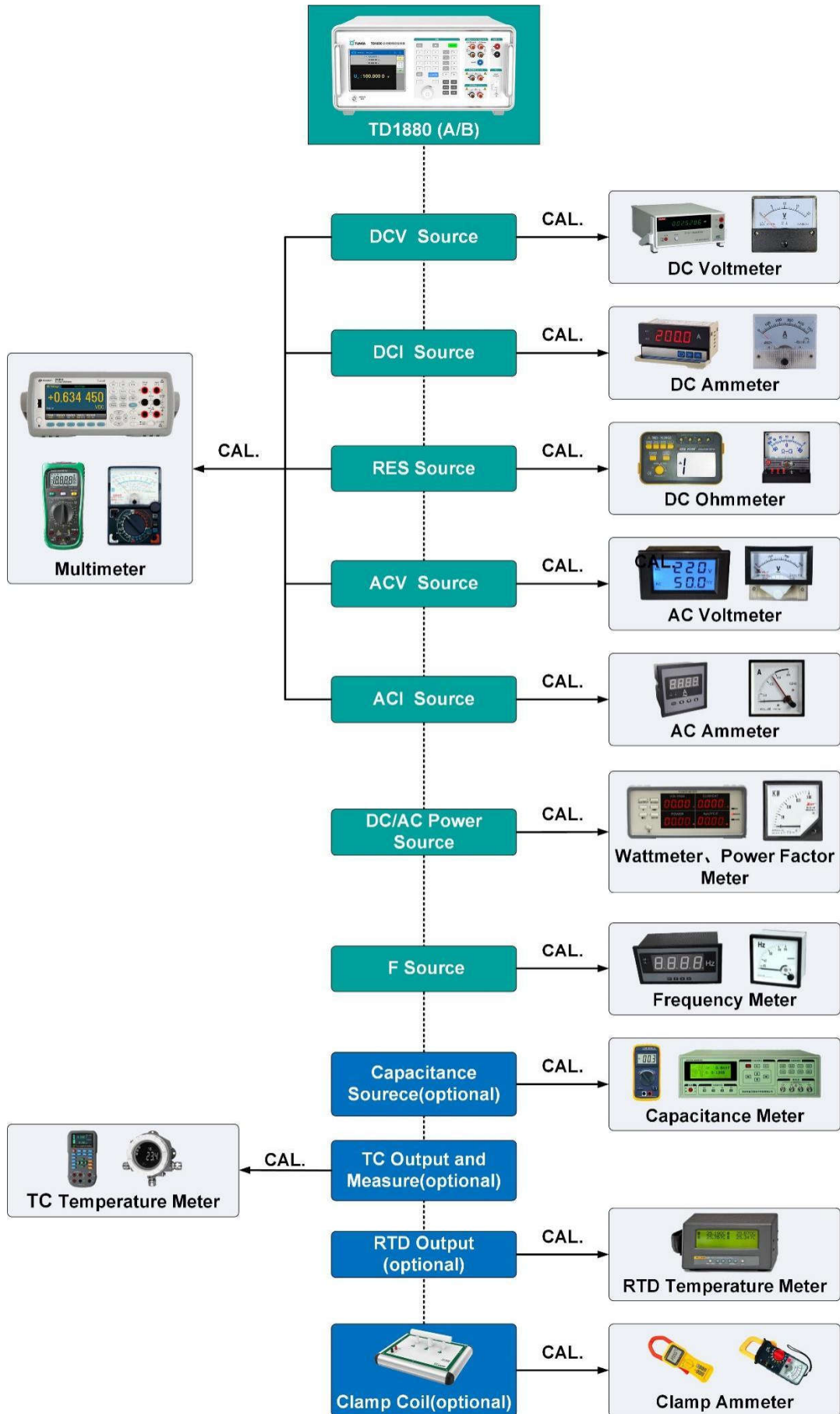

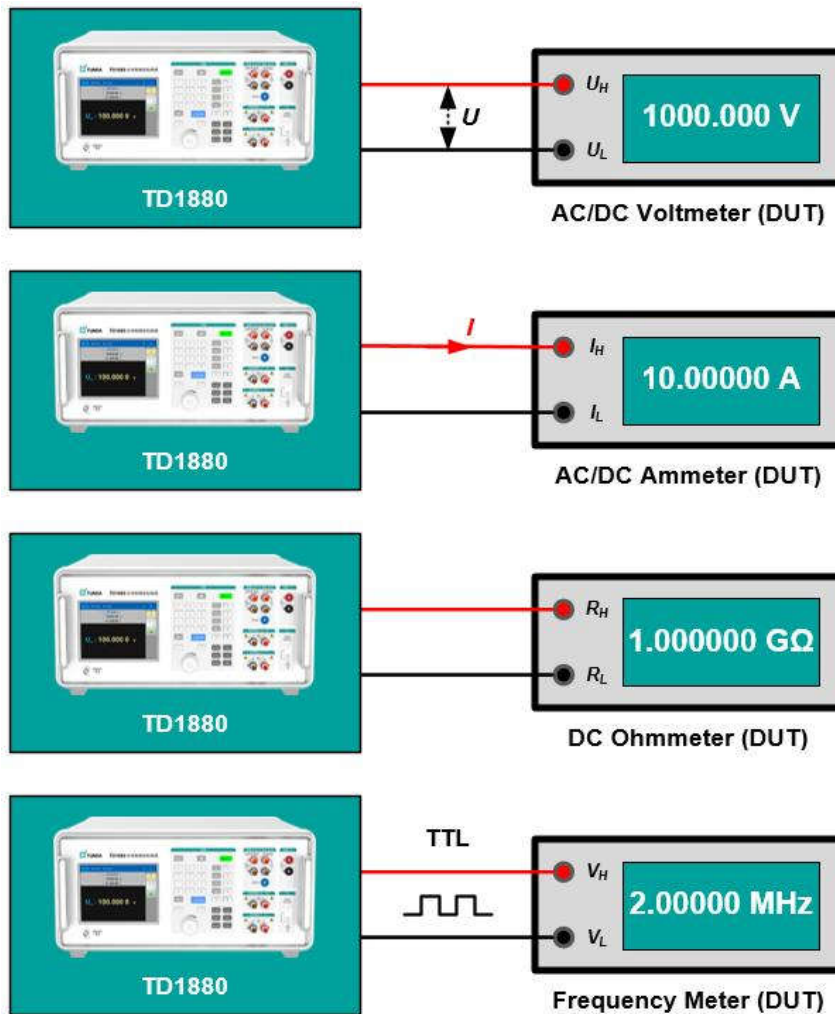
☆ Calibrate AC\DC Electrical Measuring Instruments

- **DCV Output:** $\pm(0 \sim 1020 \text{ V})$
- **DCI Output:** $\pm(0 \sim 20.5 \text{ A})$
- **ACV Output:** 1 mV~1020 V、10 Hz ~ 500 kHz
- **ACI Output:** 29 μA ~ 20.5 A、10 Hz ~ 30 kHz
- **RES Output:** 0 Ω ~ 1100 M Ω
- **F Output:** 1 Hz ~ 2 MHz
- It is suitable for calibrating digital multimeters of 6.5 digits and below, DC voltmeters and DC resistance meters of Class 0.01 and below, DC ammeters and AC voltmeters of Class 0.05 and below, AC ammeters of Class 0.1 and below, and Class 0.01 and below The frequency meter.

☆ Calibrate AC\DC Power Meters

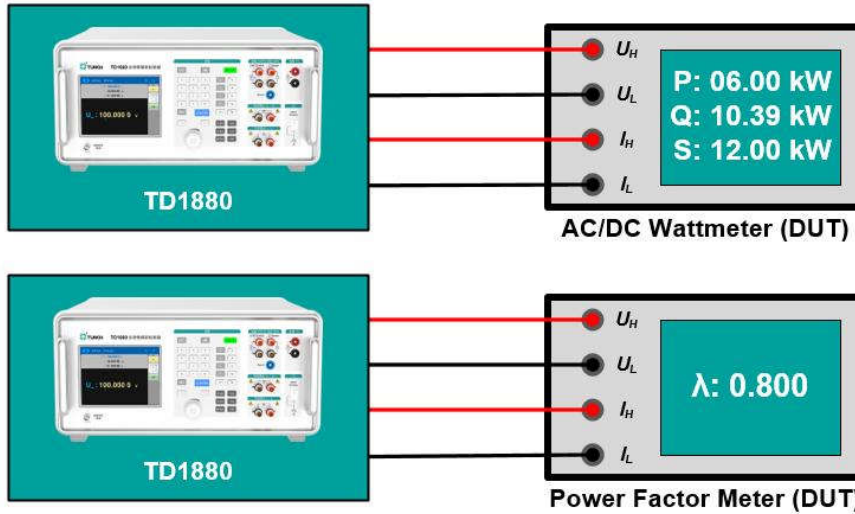

- Application: A virtual power standard source composed of independent output of AC and DC voltage (DCV / ACV) and AC and DC current (DCI / ACI) with adjustable phase, suitable for calibrating AC and DC power meters with conventional U-I measurement methods.
- It is suitable for calibrating DC power meters of Class 0.05 and below, active power meters of Class 0.1 and below, reactive power meters, apparent power meters, power frequency phase meters, power factor meters, and power analyzers.

☆ Calibrate Capacitance Meters(optional)

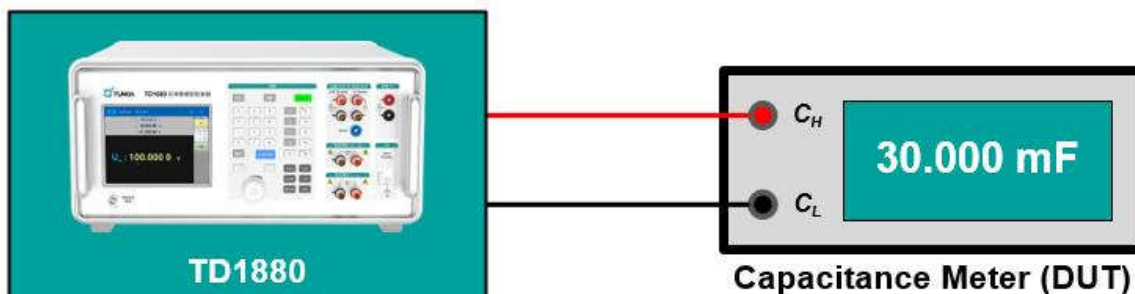

- Capacitance standard source (CAP) Output range: 1.1 nF~30 mF, 0 ~ 3 kHz
- Suitable for calibrating capacitance meters and capacitance testers of Class 1 and below.

☆ Calibrate Temperature Meters(optional)

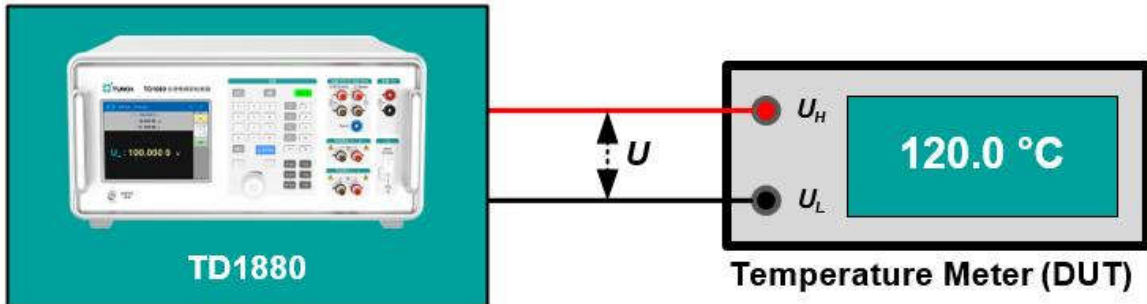

- Type of Thermocouple (TC) Output and Measurement: B, E, J, K, N, R, S, T (8 types)
- Type of Thermal Resistance (RTD) Output: Pt385-100Ω、Pt385-200Ω、Pt385-500Ω、Pt385-1000Ω、Cu50、Cu100 (6 types)

☆ Calibrate Clamp Ammeter (optional)

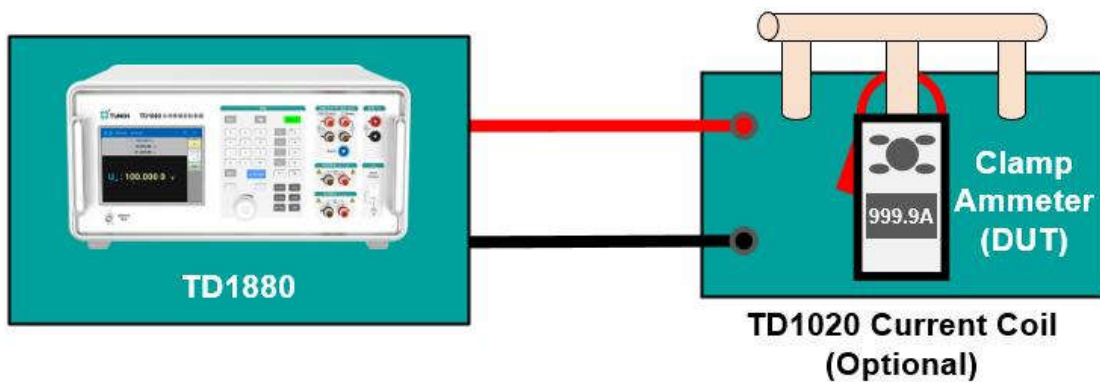

- Equivalent to 1000AT current through input 20A current to the 50T Coil, which is suitable for calibrating DC clamp meters.

4. Panel Features

☆ Front Panel

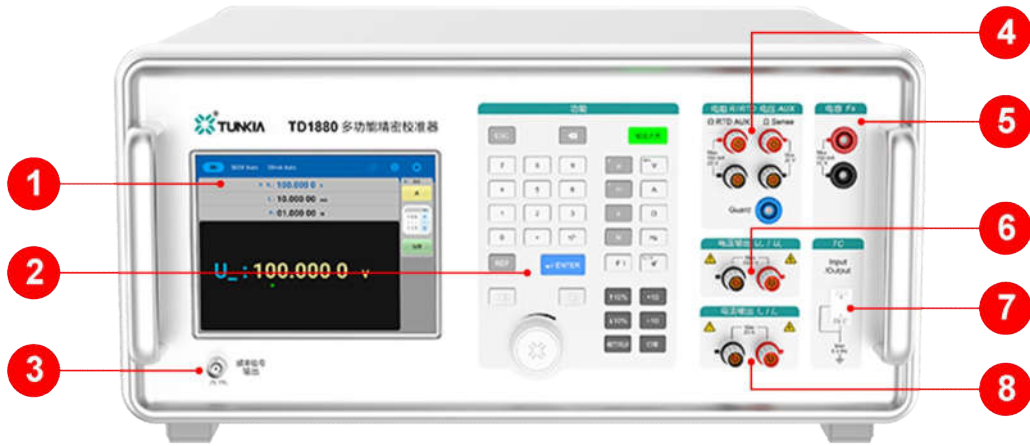

Number	Function
1	LCD touch screen.
2	Operation panel.
3	Pulse frequency output terminal.
4	Simulated DC resistance, RTD output terminals.
5	Simulated capacitance output terminals.
6	AC/DC voltage output terminals.
7	Thermocouple output terminals.
8	AC/DC current output terminals.

☆ Rear\Side Panel

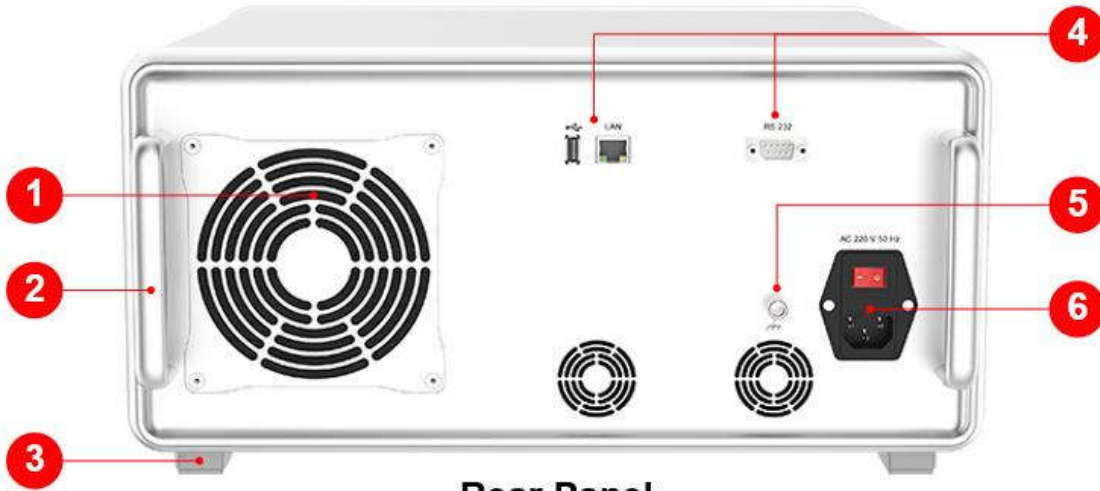

Rear Panel











Side Panel

Number	Function
1	Cooling vents
2	Handle: used for carrying instruments
3	Foldable feet
4	Communication Interface: USB/LAN/RS232
5	Chassis ground binding post
6	AC 220V power interface

5. Characteristics

☆Wide Output Range

	1n	1μ	1m	1	1k	1M	1G
DCV	1 mV  1020 V						
DCI	10 μA  20.5 A						
RES	1 Ω  1.1 GΩ						
ACV	1 mV  1020 V						
ACI	29 μA  20.5 A						
F_~	10 Hz  500 kHz						
F_{~L}	1 Hz  2 MHz						
P_{UI}	30 mV × 3 mA  1020 V × 20.5 A						
CAP	1.1 nF  30 mF						

☆ High Stability and Accuracy

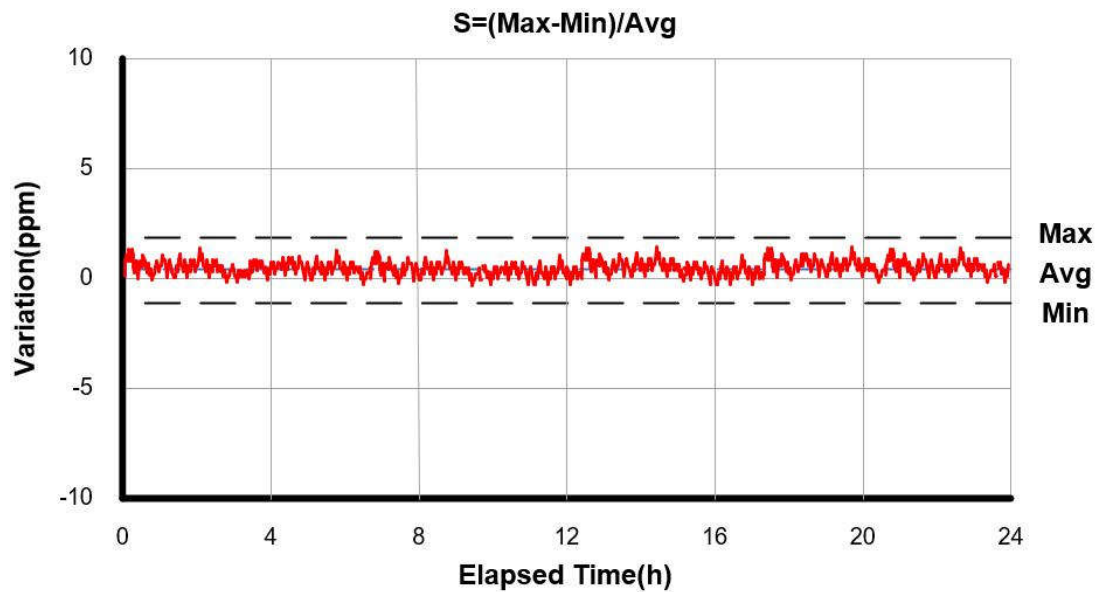

- The DC voltage stability is up to 2 ppm/24h.

☆ 4-terminals Simulated DC Resistance

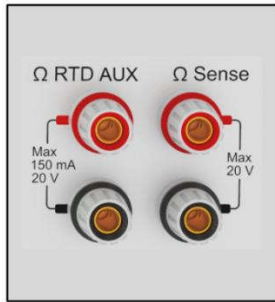

Figure(a) 4 terminals

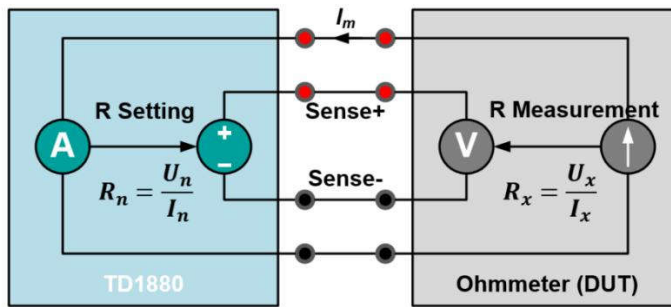

Figure(b) Wiring Diagram

- 2-terminals and 4-terminals resistance wiring mode. When calibrating the low value resistance, the four wire system wiring mode can effectively eliminate the measurement error caused by the resistance of the test lead and improve the measurement accuracy.
- Compared with the standard physical resistance box, the analog resistance output has the following characteristics:
 - ☑ Continuously adjustable, with better adjustment fineness and sensitivity
 - ☑ Smaller size and lighter weight
 - ☑ No effect of transfer switch error, residual resistance error and contact resistance error

☆ Security Protection Function

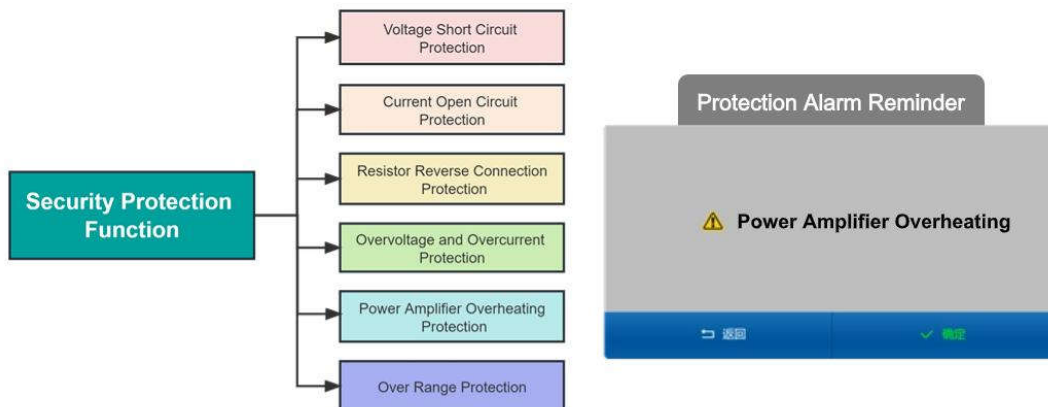

- TD1880 has a complete safety circuit protection function. When self-protection is triggered, the device will alarm and an alarm prompt will pop up on the screen interface. After the user checks and confirms and eliminates the fault, it only needs to operate the protection reset with one key to return to the normal state.

☆ Easy to Operate



Large LCD Touch Screen

Digital Programmable Keypad

Front Panel Wiring

- **Large Color Touch Screen:** Full-color with high brightness and clear image quality, supports touch operation, versatile and user-friendly.
- **Digital Programmable Keypad:** Enables various input methods such as fixed-point output, rotary encoder, and step adjustment, providing convenient and quick operation.
- **Front Panel Wiring:** Facilitates users to replace current and voltage testing wires during metering.
- **Solution Value:** This combination of operating methods effectively enhances convenience, catering to diverse application scenarios.

☆ Multiple Output\Adjustment Methods



Figure (a) Keypad

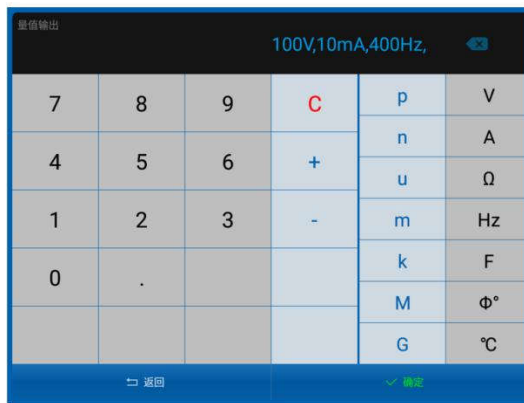

Figure (b) Touch Screen Output

- **“Direct Output”** mode: the value output can be set directly by physical key or touch screen.

★ Multiple Output\Adjustment Methods



Rotary Knob

U : 100.0000 V

U : 100.1000 V

- “Rotary Knob” mode, User can set in clockwise direction or anticlockwise direction.



% Setting

Output

U_H 100.0000 V
U_L

U_H 110.0000 V
U_L

↑10% Output

U_H 90.0000 V
U_L

↓10% Output

U_H 1000.0000 V
U_L

×10 Output

U_H 10.00000 V
U_L

÷10 Output

- Use the key $\uparrow 10\%$ 、 $\downarrow 10\%$ 、 $\times 10$ 、 $\div 10$ on the front panel, can realize the adjustment of the quantity value, and can also be used to perform the relevant test of linearity.

☆ Special Test Software (optional)

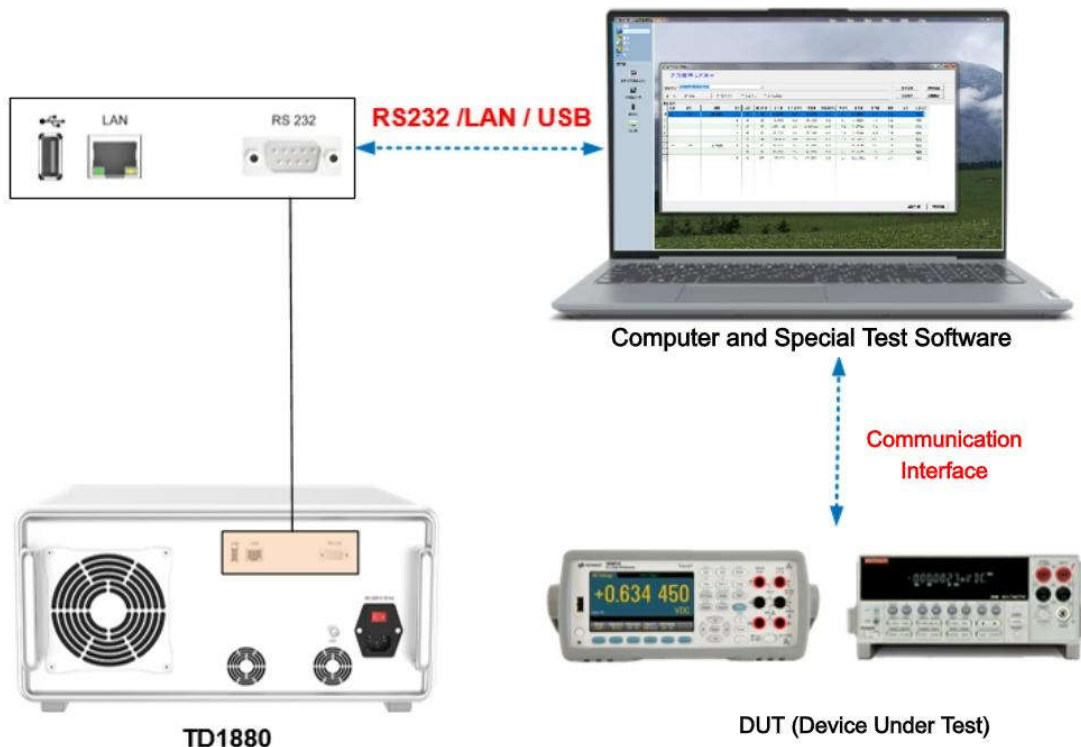

- The measurement and calibration workload of digital meters and analog meters is huge, and the measurement standards are relatively complicated. However, the human interference factors of traditional manual measurement are relatively large, the reliability of calibration results is not high enough, and the efficiency of measurement and calibration is low.
- Users can choose the special calibration software independently developed by TUNKIA, which supports fully automatic or semi-automatic calibration of the tested equipment, raw data recording, analysis, management and export of customized template reports. Compared with traditional manual calibration, it has obvious advantages, effectively solving various inconveniences of manual manual calibration, and significantly improving work efficiency.

(Note: During automatic calibration, the tested equipment should have communication function and open communication protocol to realize data reading)

6. Specifications

6.1 DC Voltage Output

Range	Resolution	Accuracy($T_{cal}\pm 5^{\circ}\text{C}$) $\pm(\text{ppm}\cdot\text{output} + \mu\text{V})$		Stability ($T_{cal}\pm 1^{\circ}\text{C}$) $\pm(\text{ppm}\cdot\text{output} + \mu\text{V})$	Maximum Load [Internal Impedance]
		90 days	1 year	24 hours	
0~330.0000 mV	100 nV	15 + 1.5	20 + 1.5	3 + 1	[60 Ω]
0~3.300000 V	1 μV	8 + 3	10 + 3	2 + 1.5	20 mA
0~33.00000 V	10 μV	10 + 30	12 + 30	2 + 10	15 mA
30.0000 V~330.0000 V	100 μV	15 + 200	18 + 200	2.5 + 100	10 mA
100.000 V~1020.000 V	1 mV	15 + 2000	18 + 2000	3 + 300	10 mA

- Manual or automatic range switch.
- Short-circuit and overload protection.

6.2 DC Current Output

Range	Resolution	Accuracy($T_{cal} \pm 5^{\circ}C$) $\pm(\text{ppm} \times \text{output} + \mu A)$		Compliance Voltage (V)	Max Inductive Load
		90 days	1 year		
0~330.0000 μA	100 pA	80 + 0.02	100 + 0.02	11 V	400 μH
0~3.300000 mA	1 nA	65 + 0.03	80 + 0.03	11 V	
0~33.000000 mA	10 nA	60 + 0.25	80 + 0.25	9 V	
0~330.0000 mA	100 nA	60 + 2	80 + 2	7 V	
0~1.100000 A	1 μA	80 + 20	100 + 20	6 V	
1.000000 A~3.300000 A	1 μA	120 + 50	150 + 50	6 V	
3.000000 A~20.50000 A	10 μA	280 + 300	350 + 300	4 V	

- Manual or automatic range switch.
- Open-circuit and overload protection.
- Supports continuous and long-term output of current under full range.

6.3 Simulated DC Resistance

Range	Resolution	Accuracy, ($T_{cal} \pm 5^{\circ}\text{C}$) $\pm(\text{ppm} \times \text{output} + \Omega)$		Allowable Current
		90 days	1 year	
0 Ω ~11.00000 Ω	10 $\mu\Omega$	32 + 0.008	40 + 0.01	1 mA~150 mA
10.00000 Ω ~33.00000 Ω	10 $\mu\Omega$	24 + 0.012	30 + 0.015	1 mA~150 mA
30.0000 Ω ~110.0000 Ω	100 $\mu\Omega$	20 + 0.012	25 + 0.015	1 mA~80 mA
100.0000 Ω ~330.0000 Ω	100 $\mu\Omega$	20 + 0.016	25 + 0.02	1 mA~40 mA
0.300000 k Ω ~1.100000 k Ω	1 m Ω	20 + 0.016	25 + 0.02	1 mA~20 mA
1.000000 k Ω ~3.300000 k Ω	1 m Ω	20 + 0.16	25 + 0.2	0.1 mA~6 mA
3.00000 k Ω ~11.00000 k Ω	10 m Ω	20 + 0.16	25 + 0.1	0.1 mA~2 mA
10.00000 k Ω ~33.00000 k Ω	10 m Ω	22 + 0.8	28 + 1	10 μA ~0.6 mA
30.0000 k Ω ~110.0000 k Ω	100 m Ω	22 + 0.8	28 + 1	10 μA ~0.2 mA
100.0000 k Ω ~330.0000 k Ω	100 m Ω	25 + 8	32 + 10	1 μA ~60 μA
0.300000 M Ω ~1.100000 M Ω	1 Ω	25 + 8	32 + 10	1 μA ~20 μA
1.000000 M Ω ~3.300000 M Ω	1 Ω	40 + 120	60 + 150	0.25 μA ~6 μA
3.00000 M Ω ~11.00000 M Ω	10 Ω	104 + 200	130 + 250	0.25 μA ~2 μA
10.00000 M Ω ~33.00000 M Ω	10 Ω	200 + 2500	250 + 2500	25 nA~600 nA
30.0000 M Ω ~110.0000 M Ω	100 Ω	400 + 3000	500 + 3000	25 nA~200 nA
100.0000 M Ω ~330.0000 M Ω	100 Ω	2400 + 100000	3000 + 100000	2.5 nA~60 nA
300.000 M Ω ~1100.000 M Ω	1 k Ω	11000 + 480000	14000 + 480000	1 nA~20 nA

- Manual or automatic range switch.
- Over-current and reverse connection protection.

6.4 AC Voltage Output (Sinusoidal Wave)

Range	Frequency (Hz)	Accuracy($T_{cal} \pm 5^{\circ}C$) $\pm(\text{ppm} \cdot \text{output} + \mu V)$		Resolution	Max Burden [Source internal resistance]
		90 days	1 year		
1.00000 mV~ 33.00000 mV	10≤F≤45	600 + 6	800 + 6	10 nV	[10 Ω]
	45<F≤10k	100 + 6	120 + 6		
	10k<F≤20k	160 + 6	200 + 6		
	20k<F≤50k	800 + 6	1000 + 6		
	50k<F≤100k	2800 + 12	3500 + 12		
	100k<F≤500k	6000 + 50	8000 + 50		
30.0000 mV~ 330.0000 mV	10≤F≤45	250 + 8	300 + 8	100 nV	[60 Ω]
	45<F≤10k	112 + 8	140 + 8		
	10k<F≤20k	130 + 8	160 + 8		
	20k<F≤50k	280 + 8	350 + 8		
	50k<F≤100k	600 + 20	750 + 20		
	100k<F≤500k	1600 + 70	2000 + 70		
0.300000 V~ 3.300000 V	10≤F≤45	250 + 50	300 + 50	1 μV	20 mA
	45<F≤10k	80 + 50	100 + 50		
	10k<F≤20k	150 + 50	180 + 50		
	20k<F≤50k	240 + 50	300 + 50		
	50k<F≤100k	550 + 100	700 + 100		
	100k<F≤500k	2000 + 600	2400 + 600		
3.00000 V~ 33.00000 V	10≤F≤45	160 + 650	200 + 650	10 μV	15 mA
	45<F≤10k	80 + 500	100 + 500		
	10k<F≤20k	160 + 500	200 + 500		
	20k<F≤50k	280 + 500	350 + 500		
	50k<F≤100k	350 + 1500	550 + 1500		
30.0000 V~ 330.0000 V	45≤F≤1k	80 + 2000	100 + 2000	100 μV	30 mA ^[1]
	1k<F≤10k	80 + 6000	100 + 6000		
	10k<F≤20k	160 + 6000	200 + 6000		

	20k<F≤50k	240 + 6000	300 + 6000		
	50k<F≤100k	1200 + 50000	1500 + 50000		
300.000 V~ 1020.000 V	45≤F≤1k	100 + 10000	120 + 10000	1 mV	8 mA ^[2]
	1k<F≤5k	120 + 10000	150 + 10000		
	5k<F≤10k	160 + 10000	200 + 10000		

Note: [1] When the output frequency ≤ 3kHz, the maximum load is 30 mA; When the output frequency >3kHz, the maximum load is 5 mA.

[2] When the output frequency ≤ 3kHz, the maximum load is 8 mA; When the output frequency >3kHz, the maximum load is 3 mA.

- Manual or automatic range switch.
- Open-circuit and overload protection.

6.5 AC Current Output (Sinusoidal Wave)

Range	Frequency (Hz)	Accuracy($T_{cal} \pm 5^{\circ}C$)		Resolution	Compliance Voltage (rms)	Max Inductive Load
		$\pm(\% * \text{output} + \mu A)$				
		90 days	1 year			
29.0000 $\mu A \sim$ 330.0000 μA	10 $\leq F \leq$ 20	0.08 + 0.1	0.1 + 0.1	0.1 nA	7 V	200
	20 < F \leq 45	0.04 + 0.1	0.05 + 0.1			
	45 < F \leq 1k	0.024 + 0.1	0.03 + 0.1			
	1k < F \leq 5k	0.08 + 0.1	0.1 + 0.1			
	5k < F \leq 10k	0.16 + 0.2	0.2 + 0.2			
	10k < F \leq 30k	0.64 + 0.4	0.8 + 0.4			
0.300000 mA \sim 3.300000 mA	10 $\leq F \leq$ 20	0.04 + 1.5	0.05 + 1.5	1 nA	7 V	200
	20 < F \leq 45	0.028 + 0.1	0.035 + 0.1			
	45 < F \leq 1k	0.024 + 0.1	0.03 + 0.1			
	1k < F \leq 5k	0.024 + 0.2	0.03 + 0.2			
	5k < F \leq 10k	0.024 + 0.5	0.03 + 0.5			
	10k < F \leq 30k	0.16 + 0.6	0.2 + 0.6			
3.000000 mA \sim 33.000000 mA	10 $\leq F \leq$ 20	0.04 + 2	0.05 + 2	10 nA	7 V	50
	20 < F \leq 45	0.02 + 2	0.025 + 2			
	45 < F \leq 1k	0.016 + 2	0.02 + 2			
	1k < F \leq 5k	0.016 + 3	0.02 + 3			
	5k < F \leq 10k	0.04 + 5	0.05 + 5			
	10k < F \leq 30k	0.16 + 6	0.2 + 6			
30.0000 mA \sim 330.0000 mA	10 $\leq F \leq$ 20	0.04 + 20	0.05 + 20	100 nA	5 V	50
	20 < F \leq 45	0.02 + 20	0.025 + 20			
	45 < F \leq 1k	0.012 + 30	0.015 + 30			
	1k < F \leq 5k	0.016 + 30	0.02 + 30			
	5k < F \leq 10k	0.016 + 100	0.02 + 100			
	10k < F \leq 30k	0.08 + 500	0.1 + 500			
0.100000 A \sim 1.100000 A	10 $\leq F \leq$ 20	0.04 + 100	0.05 + 100	1 μA	5 V	2.5
	20 < F \leq 45	0.024 + 50	0.03 + 50			

	45<F≤1k	0.016 + 50	0.02 + 50			
	1k<F≤5k	0.016 + 100	0.02 + 100			
	5k<F≤10k	0.04 + 500	0.05 + 500			
1.000000 A~ 3.300000 A	10≤F≤20	0.04 + 100	0.05 + 100	1 μA	4 V	2.5
	20<F≤45	0.024 + 100	0.03 + 100			
	45<F≤1k	0.016 + 100	0.02 + 100			
	1k<F≤5k	0.032 + 100	0.04 + 100			
	5k<F≤10k	0.04 + 900	0.05 + 900			
3.000000 A~ 20.500000 A	45≤F≤100	0.024 + 1000	0.03 + 1000	10 μA	3 V	1
	100<F≤1k	0.032 + 1000	0.04 + 1000			
	1k<F≤5k	0.048 + 2000	0.06 + 2000			

- Manual or automatic range switch.
- Open-circuit and overload protection.
- Supports continuous and long-term output of current under full range.

6.6 Sinusoidal Wave Frequency Output

Range ^[1]	Resolution	Accuracy
10.00000 Hz ≤ F ≤ 99.99999 Hz	10 μHz	±0.005%
100.0000 Hz ≤ F ≤ 999.9999 Hz	0.1 mHz	±0.005%
1.000000 kHz ≤ F ≤ 9.999999 kHz	1 mHz	±0.005%
10.00000 kHz ≤ F ≤ 99.99999 kHz	10 mHz	±0.005%
100.0000 kHz ≤ F ≤ 500.0000 kHz	0.1 Hz	±0.005%

Note [1]: Output mode: AC voltage or AC current

6.7 DC Power Output

Period	Current Range Voltage Range		Accuracy ±(%* power output) ^{[1][2]}		
			3 mA ~ 300 mA	300 mA ~ 3 A	3 A ~ 20.5 A
90 days	30 mV ~ 1020 V		0.016	0.018	0.039
1 year	30 mV ~ 1020 V		0.018	0.021	0.046

Note [1]: DC power output range (virtual load): 0 ~ 20.91 kW.

Note [2]: For more accurate technical indicators of DC power, please refer to the calculation formula: $U_W = \sqrt{U_U^2 + U_I^2}$, U_U is accuracy of voltage measurement, U_I is accuracy of current measurement.

6.8 AC Power Output(45 Hz~65 Hz、λ=1)

Period	Current Range Voltage Range		Accuracy ±(%* power output) ^{[1][2]}		
			3 mA ~ 300 mA	300 mA ~ 3 A	3 A ~ 20.5 A
90 days	30 mV ~ 330 mV		0.119	0.051	0.069
	330 mV ~ 1020 V		0.115	0.041	0.064
1 year	30 mV ~ 330 mV		0.122	0.055	0.076
	330 mV ~ 1020 V		0.118	0.046	0.069

Note [1]: AC power output range (virtual load): 0.09 mW ~ 20.91 kW

Note [2]: For more accurate technical indicators of AC power under other power factors, please refer to the calculation formula: $U_P = \sqrt{U_U^2 + U_I^2 + U_\lambda^2}$, U_U is accuracy of voltage measurement, U_I is accuracy of current measurement, U_λ is the accuracy caused by power factor.

6.9 Phase and Power Factor Output

Frequency (Hz)	Voltage Range (U)	Current Range (I)	Phase Range ^[2] (φ)	Power Factor Range ^[3] (λ)
DC	0~±1020 V	0~±20.5 V	—	—
10~45	30 mV~33 V	3 mA~3.3 A	0.000°~359.999°	-1~0~1
45~1k	30 mV~1020 V	3 mA~20.5 A	0.000°~359.999°	-1~0~1
1k~5k	3 V~1020 V	30 mA~3.3 A	0.000°~359.999°	-1~0~1
5k~10k	3 V~1020 V	30 mA~3.3 A	0.000°~359.999°	-1~0~1
10k~30k	3 V~330 V	30 mA~330 mA	0.000°~359.999°	-1~0~1

Note [1]: Phase resolution: 0.001°

Note [2]: Power factor resolution: 0.000 01

Phase		Accuracy(k=2) (T _{cal} ±5°C)					
		10~65Hz	65~500Hz	500~1kHz	1k~5kHz	5k~10kHz	10k~30kHz
φ		0.1°	0.2°	0.5°	2°	5°	8°
phase (φ)	factor (λ)	Power accuracy caused by phase ^[4]					
		10~65Hz	65~500Hz	500~1kHz	1k~5kHz	5k~10kHz	10k~30kHz
0°	1.00000	0.000%	0.001%	0.004%	0.061%	0.381%	0.973%
10°	0.98481	0.031%	0.062%	0.158%	0.676%	1.917%	3.427%
20°	0.93969	0.064%	0.128%	0.321%	1.331%	3.553%	6.039%
30°	0.86603	0.101%	0.202%	0.508%	2.076%	5.412%	9.008%
40°	0.76604	0.147%	0.294%	0.736%	2.989%	7.694%	12.651%
50°	0.64279	0.208%	0.417%	1.044%	4.220%	10.767%	17.559%
60°	0.50000	0.302%	0.605%	1.515%	6.106%	15.476%	25.079%
70°	0.34202	0.480%	0.960%	2.041%	9.649%	24.326%	39.211%
80°	0.17365	0.990%	1.980%	4.953%	19.853%	49.809%	79.902%
90°	0.00000	—	—	—	—	—	—

Note [4]: Calculation formula: $U_{\lambda} = [1 - \cos(\varphi + \Delta\varphi) / \cos \varphi] \times 100\%$

6.10 Pulse Frequency Output

Range ^[1]	Resolution	Accuracy($T_{cal} \pm 5^{\circ}C$) $\pm(ppm \cdot RD + \mu Hz)$	Shake
1.000000 Hz $\leq F \leq$ 9.999999 Hz	1 μ Hz	20 + 20	<2 ns
10.00000 Hz $\leq F \leq$ 99.99999 Hz	10 μ Hz		
100.0000 Hz $\leq F \leq$ 999.9999 Hz	0.1 mHz		
1.000000 kHz $\leq F \leq$ 9.999999 kHz	1 mHz		
10.00000 kHz $\leq F \leq$ 99.99999 kHz	10 mHz		
100.0000 kHz $\leq F \leq$ 999.9999 kHz	0.1 Hz		
1.000000 MHz $\leq F \leq$ 2.000000 MHz	1 Hz		
Note [1]: The output type is TTL level.			

6.11 Capacitance(optional)

Range	Accuracy ±(%*output + Baseline Value)		Resolution	Allowable Current
	90 days	1 year		
1.100 0 nF~3.299 9 nF	0.4 + 0.04 nF	0.5 + 0.04 nF	0.1 pF	10 Hz~3 kHz
3.300 0 nF~10.999 9 nF	0.2 + 0.04 nF	0.25 + 0.04 nF	0.1 pF	10 Hz~1 kHz
11.000 0 nF~32.999 9 nF	0.2 + 0.4 nF	0.25 + 0.4 nF	0.1 pF	10 Hz~1 kHz
33.000 nF~109.999 nF	0.2 + 0.4 nF	0.25 + 0.4 nF	1 pF	10 Hz~1 kHz
110.000 nF~329.999 nF	0.2 + 0.3 nF	0.25 + 0.3 nF	1 pF	10 Hz~1 kHz
0.330 00 μF~1.099 99 μF	0.2 + 1 nF	0.25 + 1 nF	10 pF	10 Hz~600 Hz
1.100 00 μF~3.299 99 μF	0.2 + 3 nF	0.25 + 3 nF	10 pF	10 Hz~300 Hz
3.300 0 μF~10.999 9 μF	0.2 + 10 nF	0.25 + 10 nF	100 pF	10 Hz~150 Hz
11.000 μF~32.999 9 μF	0.32 + 30 nF	0.40 + 30 nF	100 pF	10 Hz~120 Hz
33.000 μF~109.999 μF	0.36 + 100 nF	0.45 + 100 nF	1 nF	10 Hz~80 Hz
110.000 μF~329.999 μF	0.36 + 300 nF	0.45 + 300 nF	1 nF	0 Hz~50 Hz
0.330 00 mF~1.099 99 mF	0.36 + 1 μF	0.45 + 1 μF	10 nF	0 Hz~20 Hz
1.100 00 mF~3.299 99 mF	0.36 + 3 μF	0.45 + 3 μF	10 nF	0 Hz~6 Hz
3.300 0 mF~10.999 9 mF	0.36 + 10 μF	0.45 + 10 μF	100 nF	0 Hz~2 Hz
11.000 0 mF~30.000 0 mF	0.6 + 30 μF	0.75 + 30 μF	100 nF	0 Hz~0.6 Hz

Note [1]: The output is continuously adjustable.

6.12 Thermocouple Output and Measurement(optional)

Type	Output Range ^{[1][2]}		Accuracy ^[3] , (T _{cal} ±5°C)	
	°C		°C	
	min	max	90days	1year
B	410	600	0.30	0.35
	600	900	0.30	0.31
	900	1800	0.26	0.30
E	-200	0	0.10	0.11
	0	600	0.07	0.08
	600	1000	0.09	0.10
J	-200	-100	0.12	0.13
	-100	750	0.09	0.09
	750	1200	0.10	0.10
K	-200	-100	0.15	0.20
	-100	1000	0.10	0.10
	1000	1370	0.12	0.12
N	-200	-100	0.20	0.25
	-100	400	0.12	0.12
	400	1300	0.10	0.12
R	-50	50	0.30	0.40
	50	300	0.28	0.32
	300	1000	0.22	0.23
	1000	1750	0.25	0.25
S	-50	50	0.30	0.40
	50	300	0.31	0.34
	300	1000	0.24	0.24
	1000	1750	0.22	0.23
T	-200	100	0.17	0.25
	-100	0	0.08	0.11
	0	400	0.08	0.08

Note [1]: Resolution: 0.01 ° C

Note [2]: Internal resistance of output source: 10 Ω

Note [3]: Excluding thermocouple error

Note [4]: Use external compensation, S, R, B, K, N, E, J, T conform to ITS-90 international temperature standard.

6.13 RTD Output(optional)

Type	Output Range ^[1]		Accuracy, (T _{cal} ±5°C)	
	°C		°C	
	Min	Max	90 days	1 year
Pt385, 100 Ω	-200	0	0.05	0.05
	0	300	0.08	0.08
	300	850	0.12	0.12
Pt385, 200 Ω	-200	250	0.04	0.04
	250	630	0.10	0.15
Pt385, 500 Ω	-200	-30	0.36	0.40
	-30	630	0.10	0.11
Pt385, 1000 Ω	-200	0	0.027	0.03
	0	300	0.054	0.06
	300	600	0.063	0.07
Cu50	-50	150	0.09	0.09
Cu100	-50	150	0.045	0.045

● Note[1]: Resolution: 0.001°C

7. General Specifications

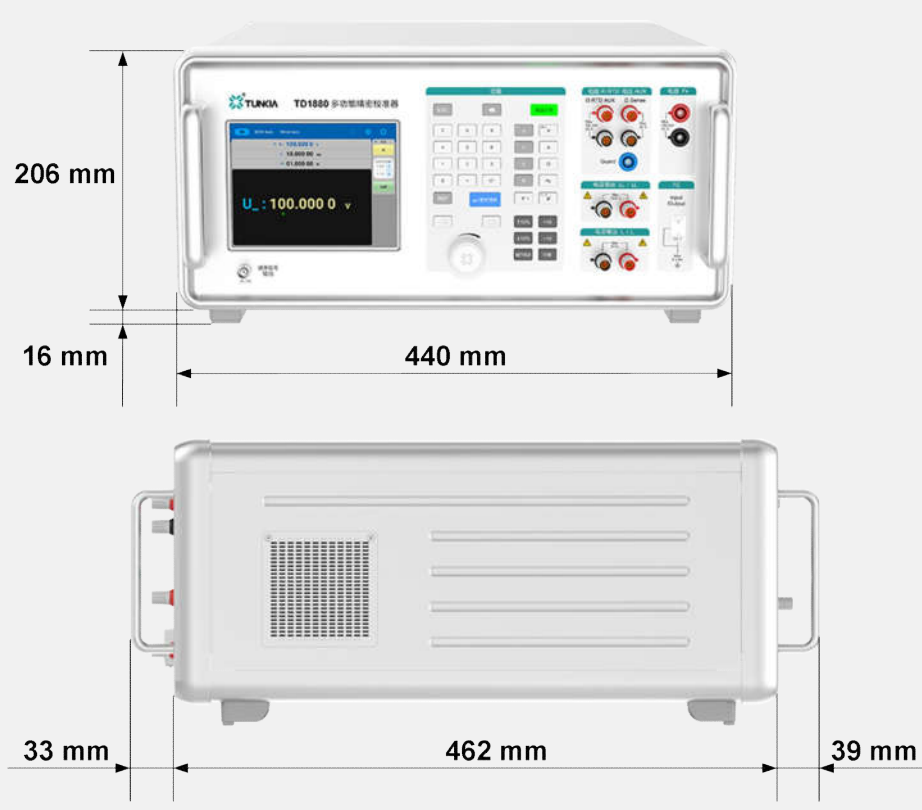



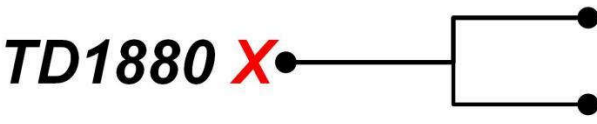





Power Supply	AC (220±22) V, (50±2) Hz
Maximum Power Consumption	500 VA
Warm Up Time	Twice the time since last warmed up, to a maximum of 30 minutes.
Temperature Performance	Operating temperature: 0°C ~ 50°C Calibration temperature: 15°C ~ 35°C Storage temperature: -20°C ~ 50°C
Humidity Performance	Operating humidity: <80% @ 30°C, <70% @ 40°C, <40% @ 50°C Storage humidity: <95%, No condensation
Altitude	< 3000 m
Communication Interface	RS232×1、USB×1、LAN×1
Dimensions	440 mm(W)× 462 mm (D) × 206 mm (H) , Handles and feet excluded.
	
Weight	About 24 kg

8. Ordering Information

	Model	
	$X = A$	Basic
	$X = B$	Standard

Function	TD1880A	TD1880B
AC/DC Voltage Standard Source (U)	★	★
AC/DC Current Standard Source (I)	★	★
Simulated DC Resistance (R)	★	★
AC/DC Power Output (P)	★	★
Square Wave Frequency Output (F_{sq})	★	★
Simulated Capacitance (C)	—	★
Simulated TC Output & TC Measurement (TC)	—	★
Simulated RTD Output (RTD)	—	★

9. Accessories List





Number	Picture	Name	Specification	Quantity	Note
1		Voltage Test Leads	1.5m / 2.1mm ² / Φ 4- Φ 4 Socket	Red 2 Black 2	Standard Accessory
2		20A Current Test Leads	1.5m / 6mm ² / Φ 4- Φ 4 Socket	Red 1 Black 1	Standard Accessory
3		Current Shorting Leads	0.18m / 1.6mm ² / Φ 4- Φ 4 Socket	Red 1 Black 1	Standard Accessory
4		Low Thermal EMF Voltage Test Leads	0.6m, Φ 8 Thin Insert	1	Standard Accessory
5		High Value Resistance Test Leads	6 in 1	1	Standard Accessory
6		Alligator Clips	Full sheath / Φ 4 Jack	Red 2 Black 2	Standard Accessory
7		Pin Adapter	Φ 2*18mm / Φ 4 Jack	Red 2 Black 2	Standard Accessory
8		U-shaped Insert	Φ 8 Thin Insert / Φ 4 Jack	Red 3 Black 3	Standard Accessory
9		Frequency Test Leads	BNC Male to Alligator Clip	1	Standard Accessory
10		Power Cable	AC 220V、10A	1	Standard Accessory

11		Case	Pelican	1	Standard Accessory
----	---	------	---------	---	-----------------------

Number	Picture	Name	Specification	Quantity	Note
1		Thermocouple Test Leads	0.6m, TC Head to $\Phi 4$ Insert	1	Thermocouple le output Functional optional Accessories

Note: The user indicates the function selection in the order contract, and the accessories with corresponding functions will be provided by default when shipped.

For example: TD1880-B has a thermocouple output function, and the delivery list includes thermocouple test leads.

Number	Picture	Name	Specification	Quantity	Note
1		Current Coil	20 A / 50 T	1	Clamp Meter Calibration
2		Current Test Leads	1.5m / 16mm ² / $\Phi 12$ - $\Phi 12$ Insert	Red 1 Black 1	Optional Accessories
3		Calibration software	Card USB	1	Software Optional
4		Communicati on Wire	1.8m / USB to RS232 (DB9 Socket)	1	Accessories

Note: The above accessories need to be purchased separately and specified in the order contract.

Tunkia are represented in South Africa by Intercal.

Intercal (Pty) Ltd

581 Lupton Drive
Halfway House
Midrand
Gauteng
South Africa

www.intercal.co.za

+27 11 315 4321
sales@intercal.co.za